

SONY[®]

4-075-587-22



FD Trinitron
WEGA[™]

Operating Instructions

KV-32FV16 **KV-36FS12** **KV-36FV16**
KV-32FV26 **KV-36FS16** **KV-36FV26**

WARNING

To reduce the risk of fire or shock hazard, do not expose the TV to rain or moisture.

NOTIFICATION

This equipment has been tested and found to comply with the limits for a Class B digital device pursuant to Part 15 of the FCC Rules. These limits are designed to provide reasonable protection

This symbol is intended to alert the user to the presence of uninsulated “dangerous voltage” within the product’s enclosure that may be of sufficient magnitude to constitute a risk of electric shock to persons.

This symbol is intended to alert the user to the presence of important operating and maintenance (servicing) instructions in the literature accompanying the appliance.

CAUTION

TO PREVENT ELECTRIC SHOCK, MATCH WIDE BLADE OF PLUG TO WIDE SLOT, FULLY INSERT.

CAUTION

When using TV games, computers, and similar products with your TV, keep the brightness and contrast functions at low settings. If a fixed (non-moving) pattern is left on the screen for long periods of time at a high brightness or contrast setting, the image can be permanently imprinted onto the screen. Continuously watching the same program can cause the imprint of station logos onto the TV screen. These types of imprints are not covered by your warranty because they are the result of misuse.

Note on Caption Vision

This television receiver provides display of television closed captioning in accordance with §15.119 of the FCC rules.

Note on Cleaning the TV

Clean the TV with a soft dry cloth. Never use strong solvents such as thinner or benzine, which might damage the finish of the cabinet.

Note to CATV System Installer

This reminder is provided to call the CATV system installer’s attention to Article 820-40 of the NEC that provides guidelines for proper grounding and, in particular, specifies that the cable ground shall be connected to the grounding system of the building, as close to the point of cable entry as practical.

Use of this television receiver for other than private viewing of programs broadcast on UHF or VHF or transmitted by cable companies for the use of the general public may require authorization from the broadcaster/cable company and/or program owner.

Important Safeguards

For your protection, please read these instructions completely, and keep this manual for future reference.

Carefully observe and comply with all warnings, cautions and instructions placed on the set, or described in the operating instructions or service manual.

WARNING

To guard against injury, the following basic safety precautions should be observed in the installation, use, and servicing of the set.

Use

Power Sources

This set should be operated only from the type of power source indicated on the serial / model plate. If you are not sure of the type of electrical power supplied to your home, consult your dealer or local power company. For those sets designed to operate from battery power, refer to the operating instructions.



Grounding or Polarization

This set is equipped with a polarized AC power cord plug (a plug having one blade wider than the other), or with a three-wire grounding type plug (a plug having a third pin for grounding). Follow the instructions below:

For the set with a polarized AC power cord plug

This plug will fit into the power outlet only one way. This is a safety feature. If you are unable to insert the plug fully into the outlet, try reversing the plug. If the plug should still fail to fit, contact your electrician to have a suitable outlet installed. Do not defeat the safety purpose of the polarized plug by forcing it in.



Alternate Warning

For the set with a three-wire grounding type AC plug

This plug will only fit into a grounding-type power outlet. This is a safety feature. If you are unable to insert the plug into the outlet, contact your electrician to have a suitable outlet installed. Do not defeat the safety purpose of the grounding plug.

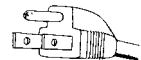

Overloading

Do not overload wall outlets, extension cords or convenience receptacles beyond their capacity, since this can result in fire or electric shock.

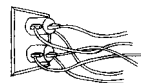

Always turn the set off when it is not to be used. When the set is left unattended and unused for long periods of time, unplug it from the wall outlet as a precaution against the possibility of an internal malfunction that could create a fire hazard.



Object and Liquid Entry

Never push objects of any kind into the set through the cabinet slots as they may touch dangerous voltage points or short out parts that could result in a fire or electric shock. Never spill liquid of any kind on the set.



Attachments

Do not use attachments not recommended by the manufacturer, as they may cause hazards.

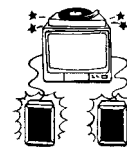

Cleaning

Unplug the set from the wall outlet before cleaning or polishing it. Do not use liquid cleaners or aerosol cleaners.



Use a cloth lightly dampened with water for cleaning the exterior of the set. If a snapping or popping sound from a TV set is continuous or frequent while the TV is operating, unplug the TV and consult your dealer or service technician. It is normal for some TV sets to make occasional snapping or popping sounds, particularly when being turned on or off.



Installation

Water and Moisture

Do not use power-line operated sets near water — for example, near a bathtub, washbowl, kitchen sink, or laundry tub, in a wet basement, or near a swimming pool, etc.

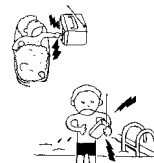

Accessories

Do not place the set on an unstable cart, stand, table or shelf. The set may fall, causing serious injury to a child or an adult, and serious damage to the set. Use only a cart or stand recommended by the manufacturer for the specific model of TV. An appliance and cart combination should be moved with care. Quick stops, excessive force, and uneven surfaces may cause the appliance and cart combination to overturn.



Ventilation

The slots and openings in the cabinet and in the back or bottom are provided for necessary ventilation. To ensure reliable operation of the set, and to protect it from overheating, these slots and openings must never be blocked or covered.

- ❑ Never cover the slots and openings with a cloth or other materials.
- ❑ Never block the slots and openings by placing the set on a bed, sofa, rug or other similar surface.
- ❑ Never place the set in a confined space, such as a bookcase, or built-in cabinet, unless proper ventilation is provided.
- ❑ Do not place the set near or over a radiator or heat register, or where it is exposed to direct sunlight.



Power-Cord Protection

Do not allow anything to rest on or roll over the power cord, and do not place the set where the power cord is subject to wear or abuse.



Antennas

Outdoor Antenna Grounding

If an outdoor antenna is installed, follow the precautions below. An outdoor antenna system should not be located in the vicinity of overhead power lines or other electric light or power circuits, or where it can come in contact with such power lines or circuits.

WHEN INSTALLING AN OUTDOOR ANTENNA SYSTEM, EXTREME CARE SHOULD BE TAKEN TO KEEP FROM CONTACTING SUCH POWER LINES OR CIRCUITS AS CONTACT WITH THEM IS ALMOST INVARIABLY FATAL. Be sure the antenna system is grounded so as to provide some protection against voltage surges and built-up static charges. Section 810 of the National Electrical Code (NEC) in USA and Section 54 of the Canadian Electrical Code in Canada provides information with respect to proper grounding of the mast and supporting structure, grounding of the lead-in wire to an antenna discharge unit, size of grounding conductors, location of antenna discharge unit, connection to grounding electrodes, and requirements for the grounding electrode.

Antenna Grounding According to the NEC

Refer to section 54-300 of Canadian Electrical Code for Antenna Grounding.

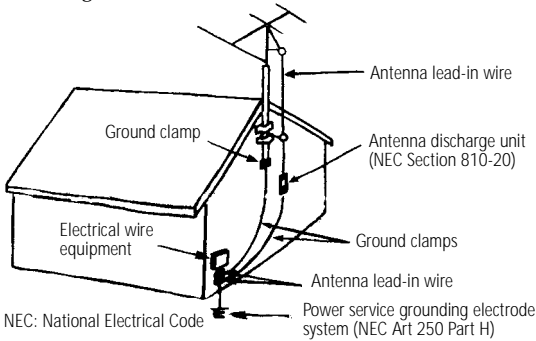

Lightning

For added protection for this television receiver during a lightning storm, or when it is left unattended and unused for long periods of time, unplug it from the wall outlet and disconnect the antenna. This will prevent damage to the receiver due to lightning and power-line surges.

Service

Damage Requiring Service

Unplug the set from the wall outlet and refer servicing to qualified service personnel under the following conditions:

- When the power cord or plug is damaged or frayed.
- If liquid has been spilled into the set.
- If the set has been exposed to rain or water.
- If the set has been subject to excessive shock by being dropped, or the cabinet has been damaged.
- If the set does not operate normally when following the operating instructions. Adjust only those controls that are specified in the operating instructions. Improper adjustment of other controls may result in damage and will often require extensive work by a qualified technician to restore the set to normal operation.
- When the set exhibits a distinct change in performance — this indicates a need for service.

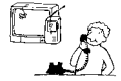
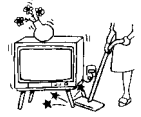
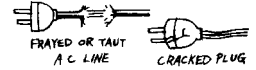

Servicing

Do not attempt to service the set yourself since opening the cabinet may expose you to dangerous voltage or other hazards. Refer all servicing to qualified service personnel.



Replacement Parts

When replacement parts are required, be sure the service technician certifies in writing that he has used replacement parts specified by the manufacturer that have the same characteristics as the original parts.

Unauthorized substitutions may result in fire, electric shock, or other hazards.

Safety Check

Upon completion of any service or repairs to the set, ask the service technician to perform routine safety checks (as specified by the manufacturer) to determine that the set is in safe operating condition, and to so certify. When the set reaches the end of its useful life, improper disposal could result in a picture tube implosion. Ask a qualified service technician to dispose of the set.



Contents

Introducing the FD Trinitron Wega

Overview	1
Presenting the FD Trinitron Wega.....	2
Using the Remote Control	3

Installing the TV

Overview	5
Connecting a Cable or Antenna.....	6
Connecting a VCR and Cable.....	9
Connecting a VCR and Cable Box.....	10
Connecting Two VCRs for Tape Editing.....	11
Connecting a Satellite Receiver.....	12
Connecting a Satellite Receiver with a VCR ...	13
Connecting an Audio Receiver	14
Connecting a DVD Player with Component Video Connectors.....	15
Connecting a DVD Player with A/V Connectors.....	16
Connecting a Camcorder	17
Using the CONTROL S Feature.....	18
Setting Up the TV Automatically	18

Using the Features

Overview	19
Using Favorite Channels.....	20
Using Picture in Picture (PIP)	21
Using Wireless Headphones	22

Using the Menus

Overview	25
Using the Video Menu	26
Using the Audio Menu	27
Using the Channel Menu.....	29
Using the Parent Menu	30
Using the Timer Menu	33
Using the Setup Menu.....	34
Using the Basic Menu.....	36

Other Information

Overview	37
TV Controls and Connectors.....	38
Using the Remote Control	40
Troubleshooting.....	46
Specifications.....	48
Index	51

Introducing the FD Trinitron Wega

Overview

This chapter defines the contents of your Wega TV, and provides an overview of how to set up and use basic features.

<i>Topic</i>	<i>Page</i>
Presenting the FD Trinitron Wega	2
Using the Remote Control	3

Presenting the FD Trinitron Wega

The FD Trinitron Wega (pronounced VAY-GAH) is characterized by outstanding contrast, uncompromising accuracy, and corner-to-corner detail.

You'll recognize the superiority of Wega technology almost immediately. The first thing you'll notice is minimal glare from the flat picture tube. This flat-screen technology improves picture detail without distortion, unlike conventional curved screens. The FD Trinitron delivers outstanding image detail not only at the screen center, but also at the corners — so you can enjoy a bright, clear picture from any location in a room.

Features

Some of the features that you will enjoy with your new TV include:

- ❑ **16:9 Enhancement:** Vertical Compression technology that maximizes picture resolution on “anamorphic” or “enhanced for widescreen” sources, including selected DVDs.
- ❑ **Velocity Modulation:** Vertical line enhancement that sharpens picture definition.
- ❑ **Steady Sound:** Equalizes volume levels so there is consistent output between programs and commercials.
- ❑ **Parental Control:** V-Chip technology allows parents to block unsuitable programming for younger viewers.
- ❑ **Component Video Inputs:** Offers the best video quality for DVD player connections.
- ❑ **S-VIDEO Inputs:** Provides a high-quality image for connected equipment.
- ❑ **Dual Tuner Picture in Picture (PIP):** Allows you to watch two programs at once, (except model KV-36FS12).
- ❑ **Favorite Channel Preview:** Preview up to eight favorite channels without leaving the current channel (except model KV-36FS12).
- ❑ **Wireless Infrared Headphones:** Enjoy listening to programs without disturbing anyone else, (models KV-32FV26, 36FV26 only).

Using the Remote Control

Inserting Batteries

Insert two size AA (R6) batteries (supplied) by matching the + and - on the batteries to the diagram inside the battery compartment.

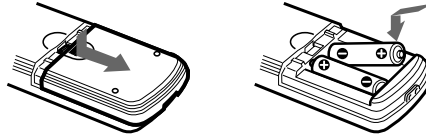

 Remove the batteries to avoid damage from possible battery leakage whenever you anticipate that the remote control will not be used for an extended period.

Handle the remote control with care. Avoid dropping it, getting it wet, or placing it in direct sunlight, near a heater, or where the humidity is high.

Remote Control Overview

Here's an overview of the buttons on the remote control you will probably use most often. For a complete description of the remote control, see "Using the Remote Control" on page 40.

<i>To Do This ...</i>	<i>Use This Button</i>
Turn the TV on and off	TV (POWER)
Select channels directly	0 - 9 and ENTER Press 0 - 9 to select a channel, the channel changes after 2 seconds. Press ENTER for immediate selection.
Scan through channels	CH +/-
Adjust the volume	VOL +/-
Switch video inputs (such as a VCR)	TV/VIDEO Press repeatedly to toggle through all video inputs.
Display the Menu to make changes to the TV	MENU For details, see "Using the Menus" on page 25.

 To scan rapidly through the channels, press and hold down the CH+ or CH- button.

Using the on-screen functions

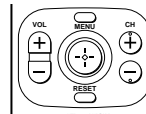

 Move
 Select

Joystick:
(models KV-32FV26,
36FV26 only)

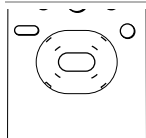

 Move
 Select

Arrow buttons:
(all models except
KV-32FV26, 36FV26)

Installing the TV

Overview

This chapter includes illustrated instructions for setting up your TV:

<i>Topic</i>	<i>Page</i>
Connecting a Cable or Antenna	6
Connecting a VCR and Cable	9
Connecting a VCR and Cable Box	10
Connecting Two VCRs for Tape Editing	11
Connecting a Satellite Receiver	12
Connecting a Satellite Receiver with a VCR	13
Connecting an Audio Receiver	14
Connecting a DVD Player with Component Video Connectors	15
Connecting a DVD Player with A/V Connectors	16
Connecting a Camcorder	17
Using the CONTROL S Feature	18
Setting Up the TV Automatically	18

Note About the AC Power Cord

The AC power cord is attached to the rear of the TV with hooks. Use caution when removing the AC plug from its holder. Gently slide the cord in the upward direction, without removing the cord from the two lower hooks.

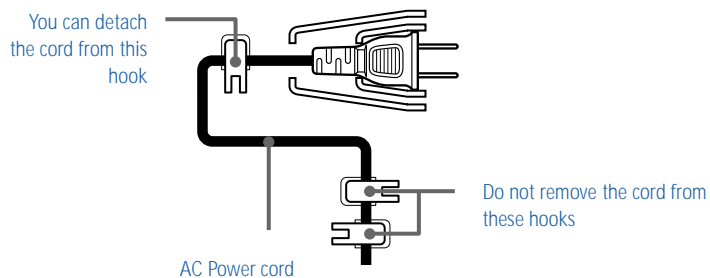

Connecting a Cable or Antenna

Connecting Directly to Cable or an Antenna

The connection you choose depends on the cable found in your home. Newer homes are equipped with standard coaxial cable (see **A**); older homes probably have 300-ohm twin lead cable (see **B**); still other homes may contain both (see **C**).

A VHF Only or VHF/UHF or Cable

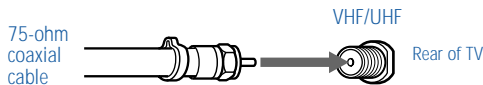

B VHF Only or UHF Only or VHF/UHF

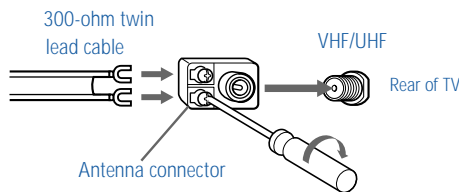

C VHF and UHF

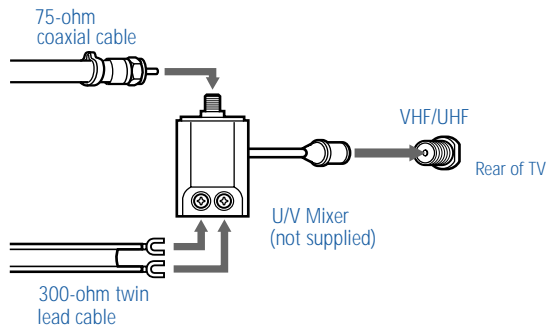

Cable and Antenna

If your cable provider does not feature local channels, you may find this set up convenient.

 This connection applies to all models except KV-36FS12.

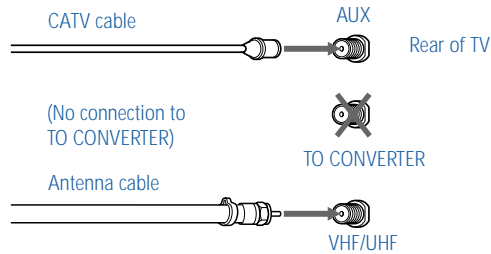

Select **CABLE** or antenna (**ANT**) mode by pressing **ANT** on the remote control.

 In order to receive channels with an antenna, you need to turn your Cable to OFF and perform the Auto Program function (see page 29).

Cable Box Connections

Some pay cable TV systems use scrambled or encoded signals that require a cable box to view all channels.

Cable Box

- 1 Connect the coaxial connector from your cable service to the cable box's IN jack.
- 2 Using a coaxial cable, connect the cable box's OUT jack to the TV's VHF/UHF jack.

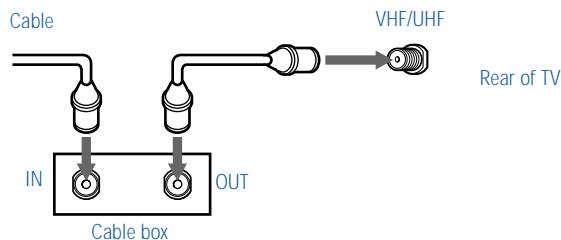



 If you will be controlling all channel selection through your cable box, you should consider using the Channel Fix feature (see page 29).

Cable Box and Cable

For this set up, you can switch between scrambled channels (through your cable box), and normal (CATV) channels by pressing ANT on the remote control.

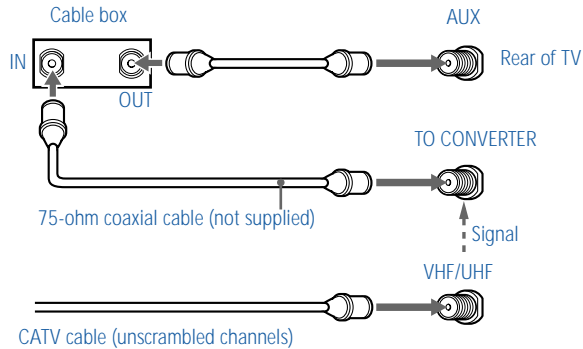
 This connection applies to all models except KV-36FS12.



 Your Sony remote control can be programmed to operate your cable box (see "Programming the Remote Control" on page 42).

When using Favorite Channel or PIP, you cannot view the AUX input in the window picture.

 Pressing ANT switches between these inputs.

 If you are connecting a cable box through the AUX input and would like to switch between the AUX and normal (CATV) input you should consider using the Channel Fix feature (see page 29).

Connecting a VCR and Cable

- 1 Connect the cable TV cable to the VCR's IN jack.
- 2 Using a coaxial cable, connect the VCR's OUT jack to the TV's VHF/UHF jack.
- 3 Using an A/V cable, connect the VCR's A/V OUT jacks to the TV's A/V IN jacks.

 If your VCR has an S VIDEO jack: For best picture quality, use an S VIDEO connection instead of the yellow video cable on your combined A/V cable. Using an S VIDEO cable, connect the VCR's S VIDEO OUT jack to the TV's S VIDEO IN jack. S VIDEO does not provide audio, so audio cables must still be connected to provide sound.

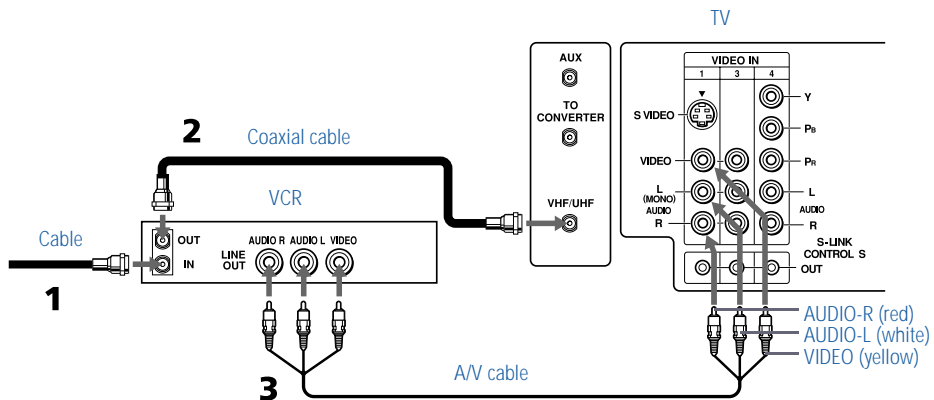

Connecting a VCR and Cable Box

 This connection applies to all models except KV-36FS12.

- 1 Connect your incoming cable connection to the TV's VHF/UHF jack.
- 2 Using a coaxial cable, connect the cable box's IN jack to the TV's TO CONVERTER jack.
- 3 Using a coaxial cable, connect the cable box's OUT jack to the VCR's VHF/UHF IN jack.
- 4 Using an A/V cable, connect the VCR's A/V OUT jacks to the TV's A/V IN jacks.

 If your VCR has an S VIDEO jack: For best picture quality, use an S VIDEO connection instead of the yellow video cable on your combined A/V cable. Using an S VIDEO cable, connect the VCR's S VIDEO OUT jack to the TV's S VIDEO IN jack. S VIDEO does not provide audio, so audio cables must still be connected to provide sound.

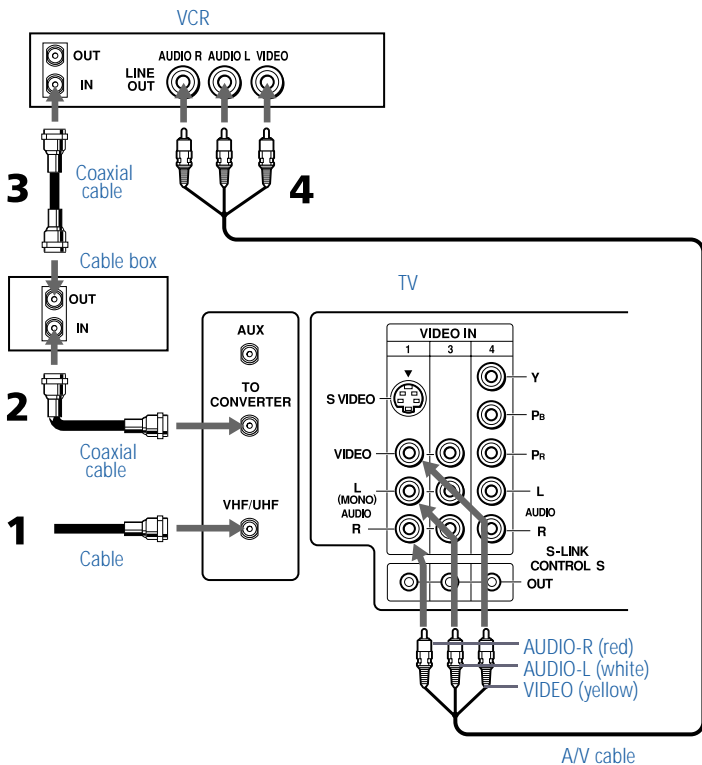

Connecting Two VCRs for Tape Editing

 This connection applies to all models except KV-36FS12 and 36FS16.

If you connect two VCRs, you can use the TV's MONITOR OUT feature to perform tape-to-tape editing. In the connection shown below, the TV functions as a monitor and sends the program being played by the playback VCR to the recording VCR.

- 1 Connect the VCR intended for playback using the connection instructions on page 10 of this manual.
- 2 Using A/V connectors, connect AUDIO and VIDEO IN on the VCR intended for recording to MONITOR AUDIO and VIDEO OUT on your TV.

 You cannot record signals from equipment connected to the Y, Pb, Pr input.

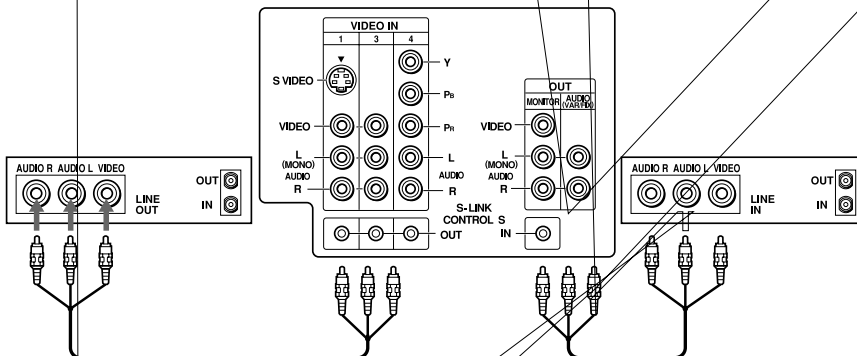

Connecting a Satellite Receiver

- 1 Connect the satellite antenna cable to the satellite receiver's SATELLITE IN jack.
- 2 Using an A/V cable, connect the satellite receiver's A/V OUT jacks to the TV's A/V IN jacks.
- 3 Connect a coaxial cable from your cable or antenna to TV's VHF/UHF jack.

 If your satellite receiver has an S VIDEO jack: For best picture quality, use an S VIDEO connection instead of the yellow video cable on your combined A/V cable. Using an S VIDEO cable, connect the satellite receiver's VIDEO OUT jack to the TV's S VIDEO IN jack. S VIDEO does not provide audio, so audio cables must still be connected to provide sound.

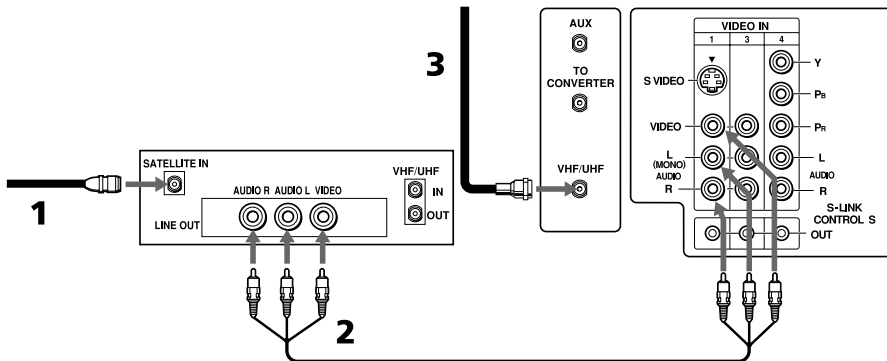

Connecting a Satellite Receiver with a VCR

- 1 Connect the satellite antenna cable to the satellite receiver's SATELLITE IN jack.
- 2 Connect the CATV cable to the VCR's VHF/UHF IN jack.
- 3 Using a coaxial cable, connect the VCR's OUT jack to the TV's VHF/UHF jack.
- 4 Using an A/V cable, connect the satellite receiver's A/V OUT jacks to the VCR's A/V IN jacks.
- 5 Using an A/V cable, connect the VCR's A/V OUT jacks to the TV's A/V IN jacks.

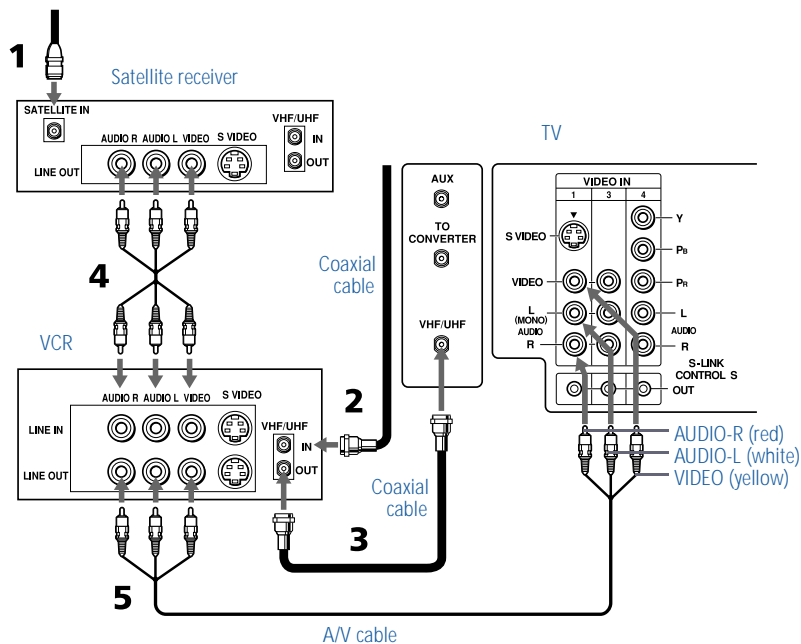

Connecting an Audio Receiver

- 1 Using audio cables, connect the TV's AUDIO OUT jacks to the audio receiver's audio LINE IN jacks.

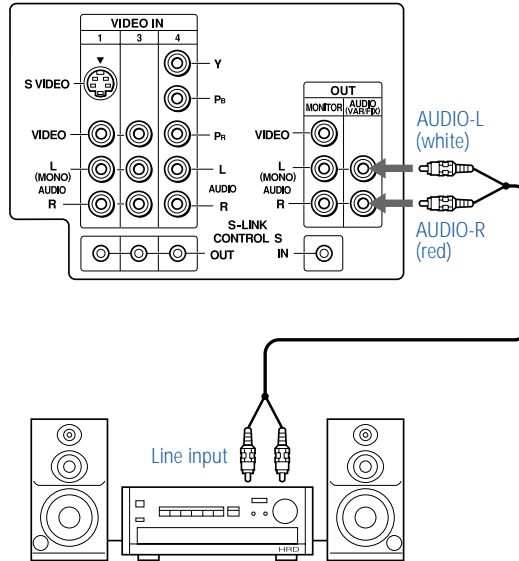

Connecting a DVD Player with Component Video Connectors

- 1 Using three separate component video cables, connect the DVD player's **Y**, **P_B**, and **P_R** jacks to the **Y**, **P_B**, and **P_R** jacks on the TV.

 The **Y**, **P_B**, and **P_R** jacks on your DVD player are sometimes labeled **Y**, **C_B**, and **C_R**, or **Y**, **B-Y**, and **R-Y**. If so, connect the cables to like colors.

The **Y**, **P_B**, and **P_R** jacks do not provide audio, so audio cables must be connected to provide sound.

- 2 Using an audio cable, connect the DVD player's audio **OUT** jacks to the TV's audio **IN** jacks.

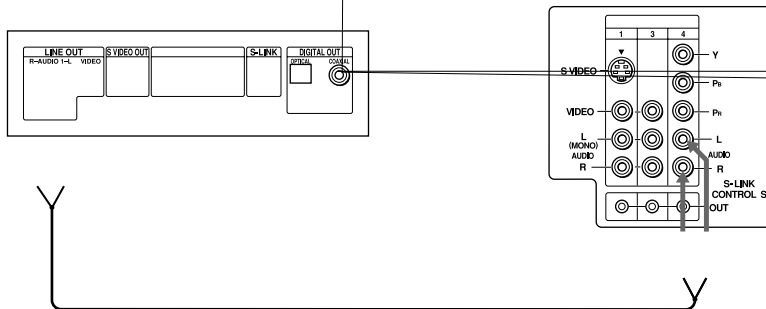

Connect DVD Player with A/V Connectors

If your DVD player has video component output connectors: for best picture quality use the connection described on page 15.

Using audio cables, connect the DVD player's audio OUT jacks to the TV's audio IN jacks.

Using an S-VIDEO cable, connect the DVD player's S-VIDEO jack to the TV's S-VIDEO jack.

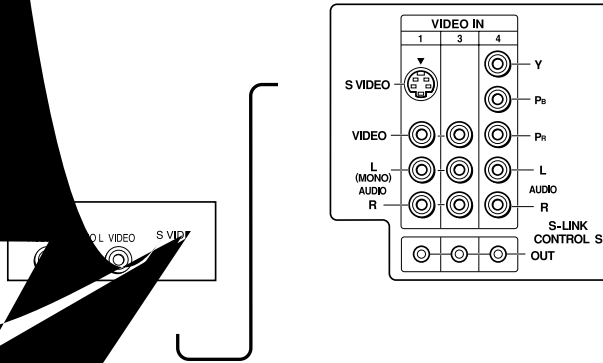

Connecting a Camcorder

- 1 Using A/V cables, connect the camcorder's A/V OUT jacks to the TV's A/V IN jacks.

 If you have a mono camcorder, connect its left audio output to the TV's AUDIO L jack.
For easy connection of the camcorder, the TV has front A/V inputs (shown below).
However, if you prefer, you can also connect the camcorder to the TV's rear A/V IN jacks.

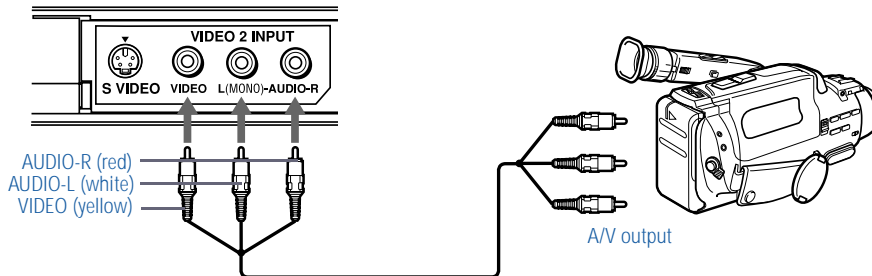

Using the CONTROL S Feature

 This CONTROL S feature applies to all models except KV-36FS12 and 36FS16.

CONTROL S allows you to control your TV system and other Sony equipment with one remote control.

To control your other Sony equipment with your TV's remote control, use a CONTROL S cable (not supplied) to connect the equipment's CONTROL S IN jack to the TV's CONTROL S OUT jack.

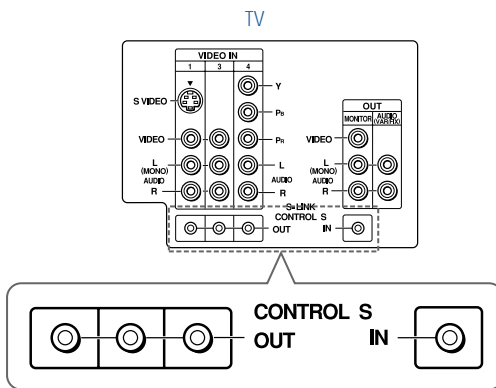

Setting Up the TV Automatically

After you finish connecting your TV, you need to run Auto Setup to set up your channels.

 The Auto Setup feature does not apply for installations that use a cable box for all channel selection.

Using Auto Setup

- 1 Press **POWER** to turn on the TV.
The first time you turn on the TV, the Auto Setup screen appears.
- 2 Press **CH+** to run Auto Setup or press **CH-** to exit.

 You can run Auto Program again by selecting it in the Channel menu, as described on page 29.

 To reset your TV to factory settings, turn the TV on. Then, while pressing the **RESET** button on the remote control, press the **POWER** button on the TV. The TV will turn itself off, then back on.

Using the Features

Overview

This chapter describes how to use new features of your TV, including:

<i>Topic</i>	<i>Page</i>	<i>Applies to Models</i>
Using Favorite Channels	20	All models
Using Picture in Picture (PIP)	21	All models except KV- 36FS12
Using Wireless Headphones	22	KV-32FV26, 36FV26 only

Using Favorite Channels

The Favorite Channel feature lets you select programs from a list of favorite channels that you specify.

 The Favorite Channel feature with preview is not included in model KV-36FS12.

To display a list of your favorite channels:



 You must specify your favorite channels before you can display them. See the Favorite Channel description under “Selecting Channel Options” on page 29.

1 Press .

 You must exit all menus (by pressing the MENU button) before you can display the Favorite Channel screen.

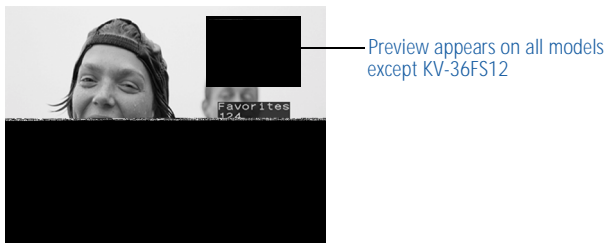
The Favorite Channel options appear.



2 Press  or  to access the channel you want to watch, and press .

Using Picture in Picture (PIP)

Picture in Picture (PIP) allows you to watch two channels simultaneously — one in the large main window and another in a small window picture.

 The Picture in Picture feature is not included in model KV-36FS12.

Displaying Picture in Picture

To display PIP:

- ❑ Press  (or the button labeled PIP):

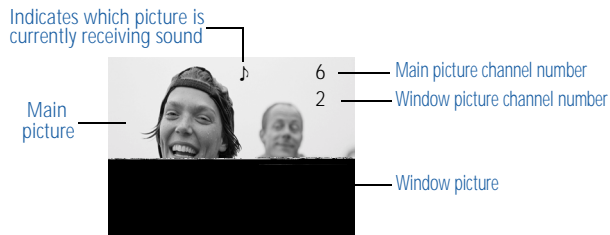

 You must press TV (FUNCTION) before you can control PIP with the yellow labeled buttons.

The AUX input cannot be viewed in the window picture.

Other PIP Functions

On models KV-32FV26 and 36FV26, buttons with asterisks (*) are located on the inside panel of the remote.

Yellow Labeled Button	Description
 or PIP	Turns on/off PIP. Press repeatedly to change the window picture size (1/9, 1/16, OFF).
* TV/VIDEO	Cycles through available video inputs: TV, VIDEO 1, VIDEO 2, VIDEO 3, VIDEO 4
* AUDIO	Alternates sound between the main picture and the window picture. The sound symbol (♪) appears, which indicates whether the main or window picture is receiving sound.
* CH +/-	Changes the channel in the window picture.
* POSITION	Moves the location of the window picture.
* FREEZE	Freezes the window picture. Press again to restore the picture.
SWAP	Switches the main picture with the window picture.

Using Wireless Headphones

 Wireless headphones are included and can only be used with models KV-32FV26 and 36FV26 only.

Installing the Batteries

Install the supplied size AA (R6) battery into the headphones.

- 1 Open the battery compartment lid by pressing and sliding the lid as illustrated.



- 2 Insert the battery into the compartment with the positive side up and then close the lid.

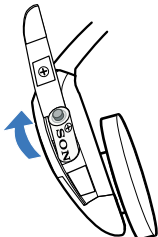

When used continuously, the battery lasts:

up to 40 hours	with an alkaline battery
up to 20 hours	with a manganese battery

Replace the battery with a new one when the sound becomes weak.

Using the Headphones

- 1 Press .

The  icon and channel number are displayed.



- 2 Turn on the power by placing the headphones securely on your head.

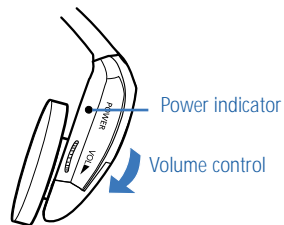



If you want to listen to the sound from only the wireless headphones, turn down the TV speaker volume, or press **MUTING** on the remote control.

- 3 To turn off the headphones, remove them from your head and press .

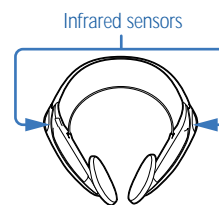
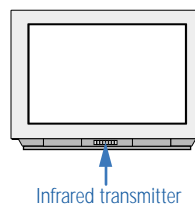
-  For optimal sound reception, do not cover the infrared transmitter on the TV or the infrared sensors on the headphones.



-  To help prevent possible hearing damage due to sudden or prolonged excessive volume, do not set the headphone volume too high while using them.

To prevent possible damage to the infrared transmitter in the television, press  to turn off the headphone feature when the headphones are not in use.

Listening to Sound from Main and Window Pictures

If you want to listen to the sound from the main or window picture through your headphones, select the audio source.

- 1 Press  to display a window picture.



- 2 Press .

The  icon and channel number appear for about three seconds.

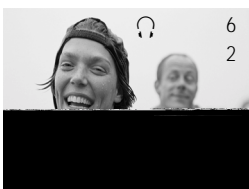

Main picture audio

Press  again to switch the audio to the window picture.

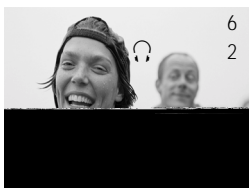

Window picture audio

- 3 Press  to turn off the headphones.

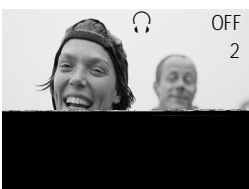

Headphones off

 Exiting from PIP returns the sound to the main picture.







The audio to the headphones automatically turns off when the TV is powered off.

SAP (Second Audio Programs) are not available in the window picture.

Using the Menu

Overview

The Menu gives you access to the following features:

<i>Menu Icon</i>	<i>Description</i>	<i>Page</i>
	Allows you to make adjustments to your picture settings. It also allows you to customize the Mode based on the type of program you are viewing.	26
	Offers enhanced audio options such as listening to second audio programming (SAP), or customizing the Effect of the sound on your TV.	27
	Allows you to set up a Favorite Channel list, run the Auto Program function, and more.	29
	Lets you control the viewing of programs based on their ratings.	30
	Lets you set the clock on your TV and allows you to program your TV for scheduled viewing using the Timers.	33
	Provides several options for setting up your channels, labeling your TV/VIDEO inputs, and selecting the language of the on-screen menus.	34
	Provides quick access to frequently used settings.	36

 To display the menu or clear it at any time, press MENU.



Using the Video Menu

To select the Video Menu

- 1 Press MENU.
- 2 Select .



To restore the factory default settings for Picture, Brightness, Color, Hue, and Sharpness

- Press RESET on the remote control when in the Video menu.

Selecting Video Options

 As a shortcut to using the menus, use the PICTURE MODE button on the remote control to select video modes.

The Video Menu includes the following options.

Option	Description	
Mode	Vivid	
<i>Customized picture viewing</i>	Standard	Select for enhanced picture contrast and sharpness.
	Movie	Select for standard picture settings.
	Sports	Select to display a softer picture.
		Select to display a vivid, bright picture.
	 You can alter the Video Menu settings (Picture, Brightness, Color, etc.) for each Mode.	
Picture	Adjust to increase picture contrast and deepen the color or decrease picture contrast and soften the color.	
Brightness	Adjust to brighten or darken the picture.	
Color	Adjust to increase or decrease color intensity.	
Hue	Adjust to increase or decrease the green tones.	
Sharpness	Adjust to sharpen or soften the picture.	
Color Temp	Choose from three color temperatures:	
<i>White intensity adjustment</i>	Cool	Select to give the white colors a blue tint.
	Neutral	Select to give the white colors a neutral tint.
	Warm	Select to give the white colors a red tint (NTSC-Standard).
VM	Sharpens picture definition to give every object a sharp, clean edge. Select from High, Low, OFF.	
<i>Velocity Modulation</i>		



Using the Audio Menu

To select the Audio Menu



- 1 Press MENU.
- 2 Select .



To restore the factory default settings for Treble, Bass, and Balance

- Press RESET on the remote control when in the Audio menu.

Selecting Audio Options

 As a shortcut to using the menus, use the  button on the remote control to cycle through available audio settings.

The Audio Menu includes the following options:

<i>Option</i>	<i>Description</i>
Treble	Adjust to decrease or increase higher-pitched sounds.
Bass	Adjust to decrease or increase lower-pitched sounds.
Balance	Adjust to emphasize left or right speaker balance.
Steady Sound	(All models except KV-36FS12 and 36FS16.)
	ON Select to stabilize the volume.
	OFF Select to turn off Steady Sound.
Effect	Simulated Adds a surround-like effect to mono programs (models KV-32FV16, 32FV26, 36FV16, and 36FV26 only).
	SRS Produces a dynamic three-dimensional sound for stereo signals (models KV-32FV16, 32FV26, 36FV16, and 36FV26 only).
	Surround Select for Surround sound (models KV-32FS12 and 36FS16 only).
	OFF Normal stereo or mono reception.

<i>Option</i>	<i>Description</i>	
MTS <i>Enjoy stereo, bilingual and mono programs</i>	Stereo	Select for stereo reception when viewing a program broadcast in stereo.
	Auto-SAP	Select to automatically switch the TV to second audio programs when a signal is received. (If no SAP signal is present, the TV remains in Stereo mode.)
	Mono	Select for mono reception. (Use to reduce noise during stereo broadcasts.)
Speaker	ON	Select to turn on the TV speakers.
	OFF	Select to turn off the TV speakers and listen to the TV's sound only through your external audio system speakers.
Audio Out <i>Easy control of volume adjustments</i>	This option can be set only when the Speaker option is set to OFF.	
	Variable	Sound output varies according to the TV settings. Useful when you want to use the TV's remote control to adjust the output through a separate audio system.
	Fixed	Sound output is held at a fixed level. Use your audio receiver's remote control to adjust the volume.



Using the Channel Menu

To select the Channel Menu

- 1 Press MENU.
- 2 Select .



Selecting Channel Options

The Channel Menu includes the following options:

<i>Option</i>	<i>Description</i>
Favorite Channel	Program up to eight of your favorite channels to appear in your Favorite Channel list. To use Favorite Channel, see page 20.
Cable	<p>ON Select if you are receiving cable channels with a CATV cable.</p> <p>OFF Select if you are using an antenna.</p> <p> You should run Auto Program after changing the Cable setting.</p>
Channel Fix <i>Useful when you have a cable box or satellite receiver connected</i>	<p>2-6 Select to control all channel selection through a cable box or satellite receiver. Select the appropriate channel number (usually 3 or 4) and use the cable box or satellite receiver's remote control for channel selection.</p> <p>AUX 2-6 (All models except KV-36FS12.) Select when a cable box or satellite receiver is connected to the AUX input (see page 8). Press the ANT button to alternate between.</p> <p>VIDEO Select from available video inputs when you have video equipment connected (e.g. satellite receiver) and you want your TV fixed to it.</p>
Auto Program	Automatically programs the TV for all receivable channels.
Channel Skip/Add	Select to remove or add channels from the channel list when using the CH+/- buttons.
Channel Label	Label up to 40 channels with their station call letters.

 Channels that you set to be skipped can be accessed only with the 0-9 buttons.



Using the Parent Menu

The Parent Menu allows you to set up the TV to block programs according to their content and rating levels.

To select the Parent Menu

- 1 Press MENU.
- 2 Select .

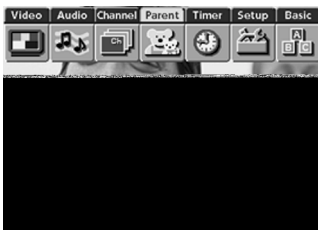

- 3 When prompted, use the 0-9 buttons on the remote control to enter a four-digit password.
- 4 Confirm your password by entering it again.

 You need this password for any future access into the Parental Control Menu. If you lose your password, see “Lost password” on page 47.

Using the Parent Menu

 If you are not familiar with the Parental Guideline rating system, you should select Child, Youth, or Young Adult to help simplify the rating selection. To set more restrictive ratings, select Custom.

 For descriptions of Child, Youth, and Young Adult ratings, see page 31.

The Parent Menu includes the following options.

Option	Description
Parental Lock	OFF Parental lock is off. No programs are blocked from viewing.
<i>Turn ratings on/off and select a rating system</i>	<ul style="list-style-type: none"> Child Maximum ratings permitted are: <ul style="list-style-type: none"> <input type="checkbox"/> US: TV-Y, TV-G, G <input type="checkbox"/> Canada: C, G Youth Maximum ratings permitted are: <ul style="list-style-type: none"> <input type="checkbox"/> US: TV-PG, PG <input type="checkbox"/> Canada: 8 ans+ Young Adult Maximum ratings permitted are: <ul style="list-style-type: none"> <input type="checkbox"/> US: TV-14, PG-13 <input type="checkbox"/> Canada: 14+, 13 ans+ Custom Select to set ratings manually. <ul style="list-style-type: none"> <input type="checkbox"/> US: See page 31 for details. <input type="checkbox"/> Canada: See page 32 for details.
Change Password	For changing your password.

US Models: Selecting Custom Rating Options

 The content ratings will increase depending on the level of the age-based rating. For example, a program with a TV-PG V (Violence) rating may contain moderate violence, while a TV-14 V (Violence) rating may contain more intense violence.

 To ensure maximum blocking capability, the age-based ratings should be blocked.

 If you choose to block unrated TV programs, please be aware that the following programs may be blocked: emergency broadcasts, political programs, sports, news, public service announcements, religious programs and weather.

For US models, the Custom Rating Menu includes the following options. For Canadian models, see page 32.

<i>Option</i>	<i>Description</i>	
Movie Rating	G	All children and General Audience.
	PG	Parental Guidance suggested.
	PG-13	Parental Guidance for children under 13.
	R	Restricted viewing, parental guidance is suggested for children under 17.
	NC-17 and X	No one 17 and under allowed.
TV Rating	Age-Based Options	
<i>Block programs by their rating, content or both</i>	TV-Y	All children.
	TV-Y7	Directed to older children.
	TV-G	General Audience.
	TV-PG	Parental Guidance suggested.
	TV-14	Parents Strongly cautioned.
	TV-MA	Mature Audience only.
		Content-Based Options
	FV	Fantasy Violence.
	D	Suggestive Dialogue.
	L	Strong Language.
	S	Sexual situations.
	V	Violence.
Unrated	Block	Blocks all programs and movies that are broadcast without a rating.
	Allow	Allows programs and movies that are broadcast without a rating.
<i>Block programs or movies that are broadcast without a rating</i>		

*Canadian Models:
Selecting Custom
Rating Options*

For Canadian models, the Custom Rating Menu includes the following options. For US models, see page 31.

<i>Option</i>	<i>Description</i>	
English Rating	C	All children.
	C8	Children 8 years and older.
	G	General programming.
	PG	Parental Guidance.
	14+	Viewers 14 and older.
	18+	Adult programming.
French Rating	G	General programming.
	8 ans+	Not recommended for young children.
	13 ans+	Not recommended for ages under 13.
	16 ans+	Not recommended for ages under 16.
	18 ans+	Programming restricted to adults.
USA Rating	See “TV Rating” on page 31 for details.	

*Viewing Blocked
Programs*

You can view a blocked program by entering the password. Press the ENTER button when tuned to a blocked program. This temporarily switches off the Parental Lock. To reactivate the Parental Lock settings, turn off the TV. When the TV is turned on again, your Parental Controls settings are reactivated.



Using the Timer Menu

To select the Timer Menu

- 1 Press MENU.
- 2 Select .

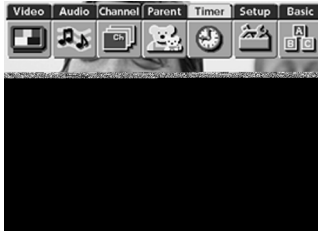

To reset the Clock or Timers

- Press RESET on the remote control when in the adjustment menu.

Selecting Timer Options

The Timer Menu includes the following options:

<i>Option</i>	<i>Description</i>	
Timer 1	Program	Select to set the Timer by day, time, duration, and channel.
Timer 2	OFF	Select to turn off the Timer. (Your previous settings will be saved.)
Current Time	Set the current time.	
Daylight Savings	ON	Select in the spring to adjust the time during Daylight Saving Time.
	OFF	Select in the fall to adjust the time at the end of Daylight Saving Time.



Using the Setup Menu

To select the Setup Menu

- 1 Press MENU.
- 2 Select .



Selecting Setup Options

The Setup Menu includes the following options:

<i>Option</i>	<i>Description</i>
Caption Vision	Allows you to select from three closed caption modes (for programs that are broadcast with closed caption).
CC1, CC2, CC3, CC4	Displays a printed version of the dialog or sound effects of a program. (Should be set to CC1 for most programs.)
TEXT1, TEXT2, TEXT3, TEXT4	Displays network/station information presented using either half or the whole screen (if available).
XDS (Extended Data Service)	Displays a network name, program name, program length, and time of the show if the broadcaster offers this service.
OFF	Turns off Caption Vision.
Video Label	Allows you to label your inputs so that you can identify connected equipment. Press TV/VIDEO to cycle through the inputs.
VIDEO 1/2/3	VHS, 8mm, Beta, LD, Game, SAT, DVD, Web, Receiver, DTV, Skip
VIDEO 4	DVD, DTV, Skip
	If you select Skip, your TV skips this connection when you press the TV/VIDEO button.
Tilt Correction	Allows you to correct any tilt of the picture.
Language	Select from available languages to display all menus in your language of choice.

 To use this feature with widescreen DVDs, set your DVD player to 16:9 aspect ratio.

<i>Option</i>	<i>Description</i>
16:9 Enhanced	Provides enhanced picture resolution for widescreen sources, such as DVD (only available when the TV is in VIDEO mode). Press TV/VIDEO and select from one of the following options:
AUTO	To activate automatically when a 16:9 signal is received (models KV-32FV26 and 36FV26 only).
ON	To activate manually.
OFF	To turn off 16:9.
Demo	Runs a demonstration of on-screen menus.





Using the Basic Menu

To select the Basic Menu

- 1 Press MENU.
- 2 Select .



Selecting Basic Options

 As a shortcut to using the menus, use the  button on the remote control to cycle through available audio settings.

The Basic Menu includes the following options:

<i>Option</i>	<i>Description</i>	
Picture	Adjust the picture contrast.	
Caption Vision	Displays your current advanced menu setting: (CC1–4, TEXT 1–4, or XDS) and OFF.	
Effect	SRS	Produces a dynamic three-dimensional sound for stereo signals (models KV-32FV16, 32FV26, 36FV16, and 36FV26 only).
	Simulated	Adds a surround-like effect to mono programs (models KV-32FV16, 32FV26, 36FV16, and 36FV26 only).
	Surround	Select for Surround sound (models KV-36FS12 and 36FS16 only).
	OFF	Normal stereo or mono reception.
Advanced Menu	Select to return to the advanced menus.	

Other Information

Overview

This chapter includes the following topics:

<i>Topic</i>	<i>Page</i>
TV Controls and Connectors	38
Using the Remote Control	40
Troubleshooting	46
Specifications	48
Index	51

TV Controls and Connectors

Front Panel Menu Controls

The front panel menu controls allow access to the on-screen menus without the use of a remote control. Pressing the MENU button brings up the on-screen menus. The arrow buttons (↕) move the on-screen cursor in the menus and the (⊕) button selects the menu item.

TV Rear Panel

Model KV-36FS12

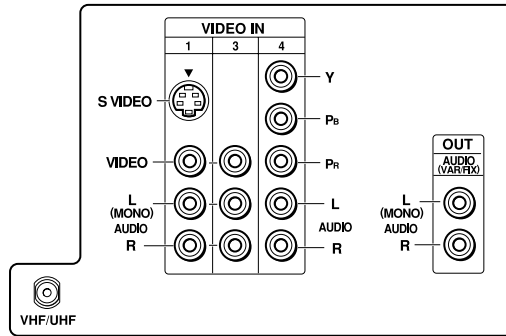

Model KV-36FS16

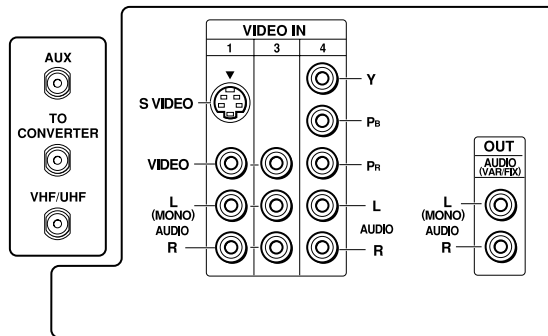

Models KV-32FV16, 32FV26, 36FV16 and 36FV26

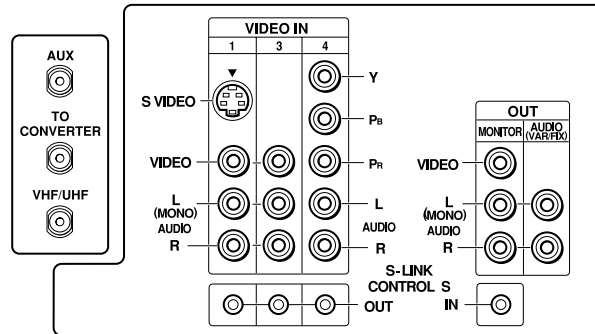

Back Panel Descriptions

Connection	Description
AUX (except KV-36FS12)	Allows you to view local (terrestrial) and cable channels if your cable provider does not feature local channels. You can switch between local and cable channels easily by pressing ANT on the remote control.
TO CONVERTER (except KV-36FS12)	Lets you set up your TV to switch between scrambled channels (through a cable box), and normal cable channels (CATV).
VHF/UHF	Connects to your VHF/UHF antenna or cable.
S VIDEO	Connects to the S VIDEO OUT jack of your VCR or other S VIDEO equipped video component.
MONITOR OUT (except models KV-36FS12 and 36FS16)	Lets you record the program you're watching to a VCR. When two VCRs are connected, (see page 11), you can use your TV as a monitor for tape to tape editing.
AUDIO (L/R)/VIDEO	Connects to the audio and video OUT jacks on your VCR or other video component. A third video input (VIDEO 2) is located on the front panel of the TV.
AUDIO OUT (VAR/FIX) L (MONO)/R	Connects to the right and left audio inputs of your audio or video component.
S-LINK CONTROL-S IN/OUT (except models KV-36FS12 and 36FS16)	Allows the TV to receive (IN) and send (OUT) remote control signals to other Sony infrared-controlled audio or video components.
Y, Pb, Pr, L, R	Connects to your DVD player's component video (Y, Pb, Pr) and audio (L, R) jacks.

Using the Remote Control

The following table describes the buttons on the remote control that are for more advanced functions.

Button Descriptions

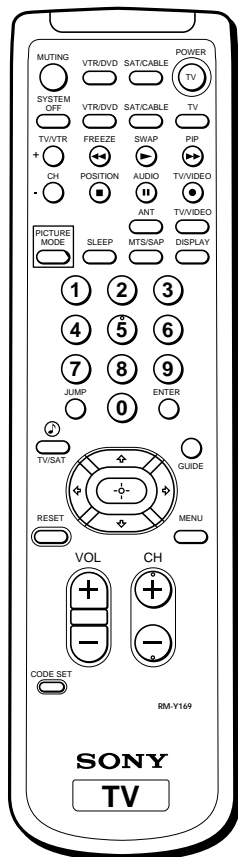

RM-Y168 is for model KV-32FS12 only. RM-Y169 is for model KV-36FS16 only. RM-Y171 is for models KV-32FV16 and 36FV16 only.

 Picture-in-Picture buttons (highlighted here) are not available on model KV-36FS12.



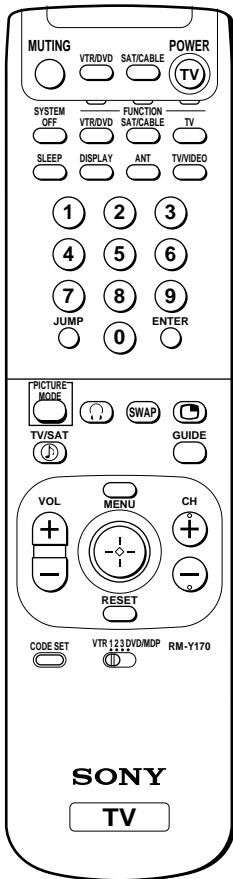

On models KV-32FV26 and 36FV26, buttons with asterisks (*) are located on the inside panel of the remote.

Button	Description
MUTING	Press to mute the sound. Press again or press VOL + to restore the sound.
VTR/DVD (POWER)	Turns the DVD player, MDP player, or VTR (VCR) on and off.
SAT/CABLE (POWER)	Turns the satellite receiver or cable box on and off.
SYSTEM OFF	Powers off all Sony equipment at once. (This feature may not work with older Sony equipment.)
VTR/DVD (FUNCTION)	Activates the remote control for use with a DVD player, MDP, or VTR (VCR).
SAT/CABLE (FUNCTION)	Activates the remote control for use with a satellite receiver or cable box.
TV (FUNCTION)	Activates the remote control for use with the TV.
* TV/VTR	Changes the VHF/UHF output of the VCR.
* FREEZE	Freezes the window picture. Press again to restore the picture.
SWAP	Switches the position of the main picture with the window picture.
PIP or 	Turns on/off PIP. For details, see “Using Picture in Picture (PIP)” on page 21.
* CH+/-	Changes the channel in the window picture.
* POSITION	Moves the location of the window picture.
* AUDIO	Alternates sound between the main picture and the window picture.
* TV/VIDEO	Cycles through available video inputs: TV, VIDEO 1, VIDEO 2, VIDEO 3, VIDEO 4.
* DVD MENU	Displays the DVD menu.
* TITLE	Displays the DVD’s Title menu.
ANT	Changes the VHF/UHF input to the AUX input.
PICTURE MODE	Press repeatedly to step through the available video picture modes: Vivid, Standard, Movie, Sports. Also available in the Video menu. For details, see “Selecting Video Options” on page 26.

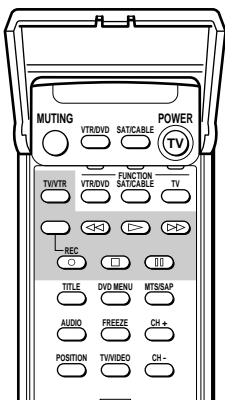

RM-Y170 is for models KV-32FV26 and 36FV26 only.

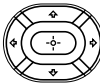

Button	Description
SLEEP	Press repeatedly until the TV displays the time in minutes (15, 30, 45, 60, or 90) that you want the TV to remain on before shutting off automatically. Cancel by pressing until SLEEP OFF appears.
* MTS/SAP	Cycles through the Multi-channel TV Sound (MTS) options: Stereo, Auto-SAP (Second Audio Program), and Mono (see page 28 for details).
DISPLAY	Press once to display the current time and channel label (if set) and channel number. Press again to turn Display off. See page 33 for details on setting the time.
JUMP	Press to jump back and forth between two channels. The TV alternates between the current channel and the last channel that was selected.
TV/SAT	Switches between the TV and SAT (satellite) inputs when in SAT FUNCTION mode.
GUIDE	Displays the program guide of your satellite antenna.
	(Models KV-32FV26, 36FV26 only.) Turns on/off the headphones. For details, see "Using Wireless Headphones" on page 22.
	Provides quick access to for changing available audio settings. For details, see "Selecting Audio Options" on page 27.
RESET	Resets the TV to the factory default settings for the Video and Audio menus.
MENU	Press to display the TV menu. Press again to exit from the menus.
	Joystick (models KV-32FV26, 36FV26 only). Allows for movement of the on-screen cursor. Pressing down on the center of the joystick selects the item.
	Arrows and Select (all models except KV-32FV26 and 36FV26). Pressing down on the center button selects the item.
CODE SET	Used for programming the remote control to operate non-Sony video equipment. For details, see "Programming the Remote Control" on page 42.
VTR 123 DVD/MDP 	(Models KV-32FV26, 36FV26 only). Use to switch control for connected video equipment. You can program one video source for each switch position (see page 42).

Programming the Remote Control

The remote control is preset to operate Sony brand video equipment.

<i>Sony Equipment</i>	<i>Switch Position on Remote Control</i>	<i>Programmable Code Number</i>
Beta, ED Beta VCRs	VTR1	303
8 mm VCR	VTR2	302
VHS VCR	VTR3	301
DVD Player	DVD/MDP	751

If you have video equipment other than Sony brand that you want to control with the TV's remote control, use the following procedures to program the remote control.

 The equipment must have infrared (IR) remote capability in order to be used with the remote control.

- 1 Turn to "Programmable Codes" on page 43, and find the three-digit code number for your equipment. If more than one code number is listed, use the number listed first to complete the following procedures.

 You must perform step 3 within 10 seconds of step 2, or you must start again from step 2.

 To check if the code number works, after step 5 aim the TV's remote control at the component and press the POWER button that corresponds with that component. If it responds, you're done. If not, try using the other codes listed for your component.

- 2 Press CODE SET.
- 3 Press VTR/DVD or SAT/CABLE. (For models KV-32FV26 and 36FV26, move the slide switch to the desired input).
- 4 Enter the three-digit code number.
- 5 Press ENTER.

Tips

- If more than one code number is listed, try entering them one by one until you come to the correct code for your equipment.
- If you enter a new code number, the code number you previously entered at that setting is erased.
- In some rare cases, you may not be able to operate your equipment with the supplied remote control. In this case, use the equipment's own remote control unit.
- Whenever you remove the batteries to replace them, the code numbers may revert to the factory setting and must be reset.

Programmable Codes

VCRs

<i>Manufacturer</i>	<i>Code</i>
Sony	301
Admiral (M. Ward)	327
Aiwa	338, 344
Audio Dynamic	314, 337
Broksonic	319, 317
Canon	309, 308
Citizen	332
Craig	302, 332
Criterion	315
Curtis Mathes	304, 338, 309
Daewoo	341, 312, 309
DBX	314, 336, 337
Dimensia	304
Emerson	319, 320, 316, 317, 318, 341
Fisher	330, 335
Funai	338
General Electric	329, 304, 309
Go Video	322, 339, 340
Goldstar	332
Hitachi	306, 304, 305, 338
Instant Replay	309, 308
JC Penney	309, 305, 304, 330, 314, 336, 337
JVC	314, 336, 337, 345, 346, 347
Kenwood	314, 336, 332, 337
LXI (Sears)	332, 305, 330, 335, 338
Magnavox	308, 309, 310
Marantz	314, 336, 337
Marta	332

<i>Manufacturer</i>	<i>Code</i>
Memorex	309, 335
Minolta	305, 304
Mitsubishi/ MGA	323, 324, 325, 326
Multitech	325, 338, 321
NEC	314, 336, 337
Olympic	309, 308
Optimus	327
Panasonic	308, 309, 306, 307
Pentax	305, 304
Philco	308, 309
Philips	308, 309, 310
Pioneer	308
Quasar	308, 309, 306
RCA/ PROSCAN	304, 305, 308, 309, 311, 312, 313, 310, 329
Realistic	309, 330, 328, 335, 324, 338
Sansui	314
Samsung	322, 313, 321
Sanyo	330, 335
Scott	312, 313, 321, 335, 323, 324, 325, 326
Sharp	327, 328
Shintom	315
Signature 2000 (M. Ward)	338, 327
SV2000	338
Sylvania	308, 309, 338, 310
Symphonic	338
Tashiro	332
Tatung	314, 336, 337
Teac	314, 336, 338, 337
Technics	309, 308
Toshiba	312, 311

<i>Manufacturer</i>	<i>Code</i>
Wards	327, 328, 335, 331, 332
Yamaha	314, 330, 336, 337
Zenith	331

Laserdisc Players

<i>Manufacturer</i>	<i>Code</i>
Panasonic	704, 710
Pioneer	702

DVD Players

<i>Manufacturer</i>	<i>Code</i>
Sony	751
Panasonic	753
Pioneer	752
RCA	755
Toshiba	754

Cable Boxes

<i>Manufacturer</i>	<i>Code</i>
Hamlin/Regal	222, 223, 224, 225, 226
Jerrold/G. I.	201, 202, 203, 204, 205, 206, 207, 208, 218
Oak	227, 228, 229
Panasonic	219, 220, 221
Pioneer	214, 215
Scientific Atlanta	209, 210, 211
Tocom	216, 217
Zenith	212, 213

Satellite Receivers

<i>Manufacturer</i>	<i>Code</i>
Sony	801
General Electric	802
Hitachi	805
Hughes	804
Panasonic	803
RCA/ PROSCAN	802, 808
Toshiba	806, 807

Operating a VCR

<i>To Do This ...</i>	<i>Press</i>
Turn on/off	VTR/DVD (POWER)
Change channels	CH +/-
Record	Except models KV-32FV26 and 36FV26: ▶ and ● simultaneously. Models KV-32FV26 and 36FV26: ● and ◯ (upper left) simultaneously.
Play	▶
Stop	■
Fast forward	▶▶
Rewind the tape	◀◀
Pause	(press again to resume normal playback)
Search the picture forward or backward	▶▶ or ◀◀ during playback (release to resume normal playback)
Change input mode	TV/VTR

Operating an MDP (Laserdisc Player)

<i>To Do This ...</i>	<i>Press</i>
Turn on/off	VTR/DVD (POWER)
Play	▶
Stop	■
Pause	(press again to resume normal playback)
Search the picture forward or backward	▶▶ or ◀◀ during playback (release to resume normal playback)
Search a chapter forward or backward	CH +/-

Operating a Satellite Receiver

To Do This ...	Press
Turn on/off	SAT/CABLE (POWER)
Select a channel	0-9 buttons, ENTER
Change channels	CH +/-
Back to previous channel	JUMP
Change input mode	TV/SAT
Display channel number	DISPLAY
Display DBS guide	GUIDE
Display DBS menu	MENU
Move highlight (cursor)	Joystick or arrows
Select item	↵ button

Operating a DVD Player

To Do This ...	Press
Turn on/off	VTR/DVD (POWER)
Play	▶
Stop	■
Pause	⏸ (press again to resume normal playback)
Step through different tracks of an audio disc	▶▶ to step forward or ◀◀ to step backward
Step through different chapters of a video disc	CH+ to step forward or CH- to step backward
Display the Title menu	TITLE (<i>models KV-32FV26, 36FV26 only</i>)
Display the DVD menu	DVD MENU (<i>models KV-32FV26, 36FV26 only</i>)
Select tracks directly	0-9 buttons
Display the menu (Setup)	MENU

Operating a Cable Box

To Do This ...	Press
Turn on/off	SAT/CABLE (POWER)
Select a channel	0-9 buttons, ENTER
Change channels	CH +/-
Back to previous channel	JUMP

Troubleshooting

<i>Problem</i>	<i>Possible Remedies</i>
No picture (screen not lit), no sound	<ul style="list-style-type: none"><input type="checkbox"/> If your TV does not turn on, and a red light keeps flashing, your TV may need service. Call your local Sony Service Center.<input type="checkbox"/> Make sure the power cord is plugged in.<input type="checkbox"/> Push the power button on the front of the TV.<input type="checkbox"/> Check to see if the TV/VIDEO setting is correct: when watching TV, set to TV, and when watching connected equipment, set to VIDEO 1, 2, 3, or 4.<input type="checkbox"/> Try another channel. It could be station trouble.
Remote control does not operate	<ul style="list-style-type: none"><input type="checkbox"/> Batteries could be weak. Replace the batteries.<input type="checkbox"/> Press TV (FUNCTION) when operating your TV.<input type="checkbox"/> Make sure the TV's power cord is connected securely to the wall outlet.<input type="checkbox"/> Locate the TV at least 3-4 feet away from fluorescent lights.<input type="checkbox"/> Check the orientation of the batteries.
Dark, poor or no picture (screen lit), good sound	<ul style="list-style-type: none"><input type="checkbox"/> Adjust the Picture setting in the Video menu (see page 26).<input type="checkbox"/> Adjust the Brightness setting in the Video menu (see page 26).<input type="checkbox"/> Check antenna/cable connections.
Good picture, no sound	<ul style="list-style-type: none"><input type="checkbox"/> Press MUTING so that "MUTING" disappears from the screen (see page 40).<input type="checkbox"/> Make sure Speaker is set to ON in the Audio menu (see page 27).
Cannot receive upper channels (UHF) when using an antenna	<ul style="list-style-type: none"><input type="checkbox"/> Change Cable to OFF (see page 29).<input type="checkbox"/> Use Auto Program in the Channel menu to add receivable channels that are not presently in TV memory (see page 29).
No color	<ul style="list-style-type: none"><input type="checkbox"/> Adjust the Color settings in the Video menu (see page 26).
Only snow and noise appear on the screen	<ul style="list-style-type: none"><input type="checkbox"/> Check the antenna/cable connections.<input type="checkbox"/> Make sure the channel is broadcasting programs.<input type="checkbox"/> Press ANT to change the input mode (see page 40).
Dotted lines or stripes	<ul style="list-style-type: none"><input type="checkbox"/> Adjust the antenna.<input type="checkbox"/> Move the TV away from noise sources such as cars, neon signs, or hair-dryers.
TV is fixed to one channel	<ul style="list-style-type: none"><input type="checkbox"/> Use Auto Program in the Channel menu to add receivable channels that are not presently in TV memory (see page 29).<input type="checkbox"/> Check your Channel Fix settings (see page 29).
Double images or ghosts	<ul style="list-style-type: none"><input type="checkbox"/> Use a highly directional outdoor antenna or a cable (when the problem is caused by reflections from nearby mountains or tall buildings).
Cannot operate menu	<ul style="list-style-type: none"><input type="checkbox"/> If the item you want to choose appears in gray, you cannot select it.
Cannot receive any channels when using cable TV	<ul style="list-style-type: none"><input type="checkbox"/> Use Auto Program in the Channel menu to add receivable channels that are not presently in TV memory (see page 29).<input type="checkbox"/> Check your cable settings.<input type="checkbox"/> Make sure Cable is set to ON in the Channel menu (see page 29).

<i>Problem</i>	<i>Possible Remedies</i>
Cannot gain enough volume when using a cable box	<input type="checkbox"/> Increase the volume of the cable box using the cable box's remote control. Then press TV (FUNCTION) and adjust the TV's volume.
Cannot receive channels	<input type="checkbox"/> Use Auto Program in the Channel menu to add receivable TV channels that are not presently in TV memory (see page 29).
Unable to select a channel	<input type="checkbox"/> Use Auto Program in the Channel menu to add receivable TV channels that are not presently in TV memory (see page 29).
Lost password	<input type="checkbox"/> In the password screen (see page 30), enter the following master password: 4357. The master password clears your previous password; it cannot be used to temporarily unblock channels.

If, after reading these operating instructions, you have additional questions related to the use of your Sony television, please call our Direct Response Center at 1-800-222-SONY (7669) (U.S. residents only) or (416) 499-SONY (7669) (Canadian residents only).

Specifications

All Models (General)

Picture Tube	FD Trinitron® tube	
Antenna	75 ohm external terminal for VHF/UHF	
Television System	NTSC, American TV Standard	
Channel Coverage		
VHF	2-13	
UHF	14-69	
CATV	1-125	
Power Requirements	120V, 60 Hz	
Number of Inputs/Outputs		
Video (IN)	3	1 Vp-p, 75 ohms unbalanced, sync negative
S Video (IN)	1 (KV-36FS12, 36FS16 only)	Y: 1 Vp-p, 75 ohms unbalanced, sync negative
	2 (except KV-36FS12, 36FS16)	C: 0.286 Vp-p (Burst signal), 75 ohms
Audio (IN)	4	500 mVrms (100% modulation)
		Impedance: 47 kilohm
Variable/Fixed Audio (OUT)	1	More than 408 mVrms at the maximum volume setting (Variable)
		More than 408 mVrms (Fixed)
		Impedance (output): 2 kilohms
Monitor Out	1 (except KV-36FS12, 36FS16)	1 Vp-p, 75 ohms unbalanced, sync negative
CONTROL-S (IN/OUT)	1 (except KV-36FS12, 36FS16)	
S Link (OUT)	3 (except KV-36FS12, 36FS16)	
Component Video Input	1 (Y, P _B , P _R)	Y: 1.0 Vp-p, 75 ohms unbalanced, sync negative; P _B : 0.7 Vp-p, 75 ohms P _R : 0.7 Vp-p, 75 ohms

KV-32FV16, 32FV26

Supplied Accessories

Remote Control		
KV-32FV16	RM-Y171	
KV-32FV26	RM-Y170	
AA (R6) Batteries		
KV-32FV16	2 supplied for remote control	
KV-32FV26	2 supplied for remote control, 1 supplied for wireless headphones	
Wireless Stereo Headphones	MDR-IF0230 (KV-32FV26 only)	

Optional Accessories

AV Cable	VMC-810/820/830 HG	
Audio Cable	RKC-515HG	
S-LINK Cable	RK-G69HG	
Component Video Cable	VMC-10/30 HG	
TV Stand	SU-32FD3	
Visible Screen Size	32 in (812.8 mm) picture measured diagonally	

KV-36FS12, 36FS16**Supplied Accessories**

Remote Control	
KV-36FS12	RM-Y168
KV-36FS16	RM-Y169
AA (R6) Batteries	2 supplied for remote control
Optional Accessories	
AV Cable	VMC-810/820/830 HG
Audio Cable	RKC-515HG
Component Video Cable	VMC-10/30 HG
TV Stand	SU-36FD3
Visible Screen Size	36 in (914.4 mm) picture measured diagonally
Actual CRT Size	38 in (965.2 mm) picture measured diagonally
Speaker Output	5 W x 2
Dimensions (W x H x D)	910 x 791 x 650 mm (35 7/8 x 31 1/8 x 25 5/8 in)
Mass	100 kg (220 lbs)
Power Consumption	
In Use	190 W
In Standby	2 W

KV-36FV16, 36FV26**Supplied Accessories**

Remote Control	
KV-36FV16	RM-Y171
KV-36FV26	RM-Y170
AA (R6) Batteries	
KV-36FV16	2 supplied for remote control
KV-36FV26	2 supplied for remote control, 1 supplied for wireless headphones
Wireless Stereo Headphones	MDR-IF0230 (KV-36FV26 only)
Optional Accessories	
AV Cable	VMC-810/820/830 HG
Audio Cable	RKC-515HG
S-LINK Cable	RK-G69HG
Component Video Cable	VMC-10/30 HG
TV Stand	SU-36FD3
Visible Screen Size	36 in (914.4 mm) picture measured diagonally
Actual CRT Size	38 in (965.2 mm) picture measured diagonally
Speaker Output	15 W x 2
Dimensions (W x H x D)	975 x 757 x 633 mm (33 3/8 x 29 3/4 x 24 7/8 in)
Mass	107 kg (236 lbs)
Power Consumption	
In Use	200 W
In Standby	2 W

Design and specifications are subject to change without notice.

Index

16:9 (widescreen) 2, 35

3-D sound, adjusting 27, 36

A

antenna, connecting

Audio menu 25, 27

audio receiver, connecting 14

Auto Program (channel setup) 18, 29

B

balance, adjusting 27

Basic menu 25, 36

bass, adjusting 27

batteries

 inserting in remote 3

 inserting in wireless headphones 22

bilingual audio 28

blocking programs. See ratings.

brightness, adjusting 26

C

cable

 box, connecting 7

 box, connecting with VCR 10

 connecting

 setting ON/OFF 29

 with VCR, connecting 9

cable box, using with TV remote control 45

camcorder, connecting 17

Caption Vision 34, 36

CATV. see cable

Channel menu 25

Channel Setup menu 29

channels

 creating labels 29

 setting up 18

closed caption modes 34

color temperature, adjusting 26

color, adjusting 26

CONTROL S 18

D

Demo, menus 35

DVD player

 using with TV remote control 45

 with A/V connectors, connecting 16

 with component video connectors, connecting 15

E

Extended Data Service 34

F

Favorite Channel

 setting up 29

 using 20

features 2

H

headphones, see wireless headphones

hue, adjusting 26

I

inputs, labeling 34

L

label

 channels 29

 video inputs 34

languages, setting for menus 34

M

MDP, using with TV remote control 44

menus

 Audio 25, 27

 Basic 25, 36

 Channel 25

 Channel Setup 29

 Parent 25

 Parental Control 30

 Setup 25, 34

 Timer 25, 33

 Video 25, 26

P

- Parent menu 25, 30
- parental control, described 2
- password
 - changing 30
 - setting 30
- picture contrast, adjusting 26
- picture definition, adjusting 26
- Picture in Picture (PIP), using 21
- picture, adjusting 36
- power cord, removing from holder 5
- presetting channels 29
- problems, troubleshooting 46-47

R

- ratings, setting 30-32
- ratings, viewing blocked programs 32
- remote control
 - described 40-41
 - inserting batteries 3
 - overview 3
 - programming 42-43
- resetting
 - Audio options 27
 - Timer options 33
 - Video options 26

S

- satellite receiver, using with TV remote control
 - 45
- setting up channels 18
- Setup menu 25, 34
- sharpness, adjusting 26
- sound effect (3-D), adjusting 27, 36
- speakers
 - turning on/off 28
 - using external speakers 28
- specifications 48-49
- Steady Sound, described 2
- surround sound 27, 36

T

- tape-to-tape editing 11
- tilt, correcting 34
- Timer menu 25, 33
- treble, adjusting 27
- troubleshooting 46-47

V

- VCR
 - connecting two, for tape editing 11
 - using with TV remote control 44
 - with cable box, connecting 10
 - with cable, connecting 9
 - with satellite receiver, connecting 13
- Velocity Modulation 2, 26
- video inputs, labeling 34
- Video menu 25, 26
- Video Modes, selecting 26

W

- Wega, described 2
- widescreen 35
- widescreen, described 2
- wireless headphones 22-24

